

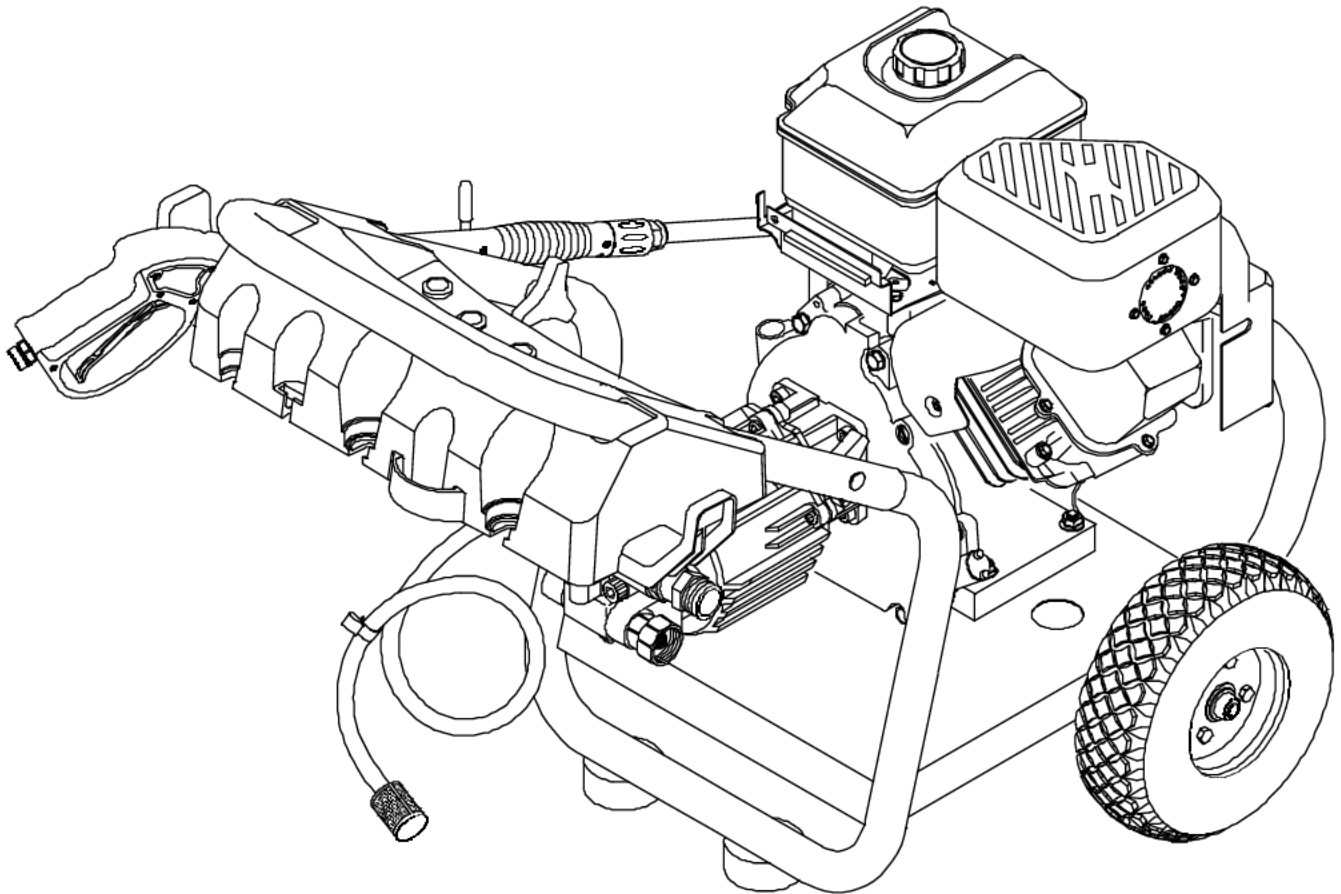

## Owner's Manual / Manual del Propietario

Pressure Washer / Lavadora de Presión  
Model / Modelo 01904



**IMPORTANT: READ SAFETY RULES AND INSTRUCTIONS CAREFULLY**  
**IMPORTANTE: LEYO LA SEGURIDAD LAS ORDENES Y LAS INSTRUCCIONES DETENIDAMENTE**

Questions? Preguntas?

Helpline - 1-888-611-6708 M-F 8-5 CT

Troy-Bilt® is a registered trademark of MTD and is used under license to Briggs & Stratton Power Products.  
Troy-Bilt® es una marca registrada registrada de MTD y se usa abajo licencia a Briggs & Stratton Power Products.

**BRIGGS & STRATTON POWER PRODUCTS GROUP, LLC**  
**JEFFERSON, WISCONSIN, U.S.A.**



Printed in USA

Manual No. 193121GS Revision I (07/08/2003)

# Safety Rules

## TABLE OF CONTENTS

Safety Rules.....	2-4
Know Your Pressure Washer .....	5
Assembly.....	6-8
Operation.....	9-12
Maintenance .....	13-15
Storage.....	16
Troubleshooting .....	17
Replacement Parts.....	18-19
Warranty.....	Last Page

## EQUIPMENT DESCRIPTION



Read this manual carefully and become familiar with your pressure washer. Know its applications, its limitations and any hazards involved.

Every effort has been made to ensure that information in this manual is accurate and current. However, we reserve the right to change, alter or otherwise improve the product and this document at any time without prior notice.

In the State of California a spark arrester is required by law (Section 4442 of the California Public Resources Code). Other states may have similar laws. Federal laws apply on federal lands. If you equip the muffler with a spark arrester, it must be maintained in effective working order.

## SAFETY RULES



This is the safety alert symbol. It is used to alert you to potential personal injury hazards. Obey all safety messages that follow this symbol to avoid possible injury or death.

The safety alert symbol (▲) is used with a signal word (DANGER, CAUTION, WARNING), a pictorial and/or a safety message to alert you to hazards. **DANGER** indicates a hazard which, if not avoided, *will* result in death or serious injury. **WARNING** indicates a hazard which, if not avoided, *could* result in death or serious injury. **CAUTION** indicates a hazard which, if not avoided, *might* result in minor or moderate injury. **CAUTION**, when used **without** the alert symbol, indicates a situation that could result in equipment damage. Follow safety messages to avoid or reduce the risk of injury or death.





### WARNING

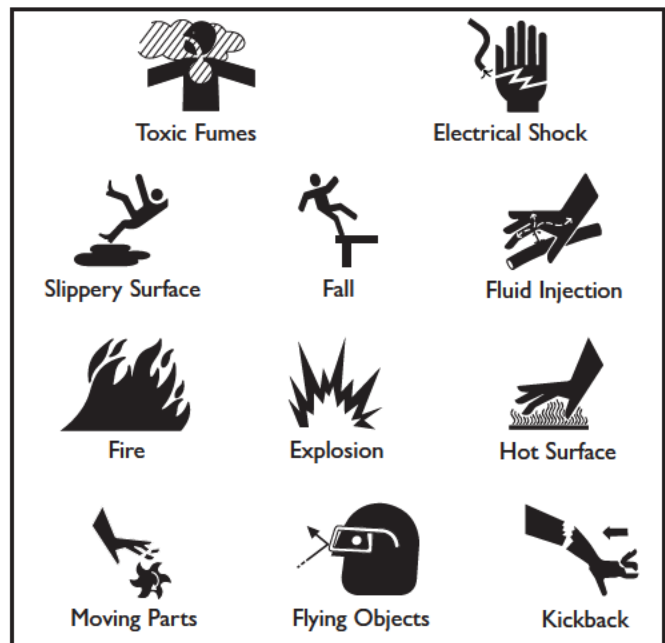

The engine exhaust from this product contains chemicals known to the State of California to cause cancer, birth defects, or other reproductive harm.



## Hazard Symbols and Meanings







# Section 1: Safety Rules

 <b>DANGER</b>	
	Running engine gives off carbon monoxide, an odorless, colorless, poison gas. Some chemicals or detergents may be harmful if inhaled or ingested, causing severe nausea, fainting or poisoning. Breathing carbon monoxide will cause nausea, fainting or death.
<ul style="list-style-type: none"><li>• Operate pressure washer <b>ONLY</b> outdoors.</li><li>• Use a respirator or mask whenever there is a chance that vapors may be inhaled.</li><li>• Read all instructions with mask so you are certain the mask will provide the necessary protection against inhaling harmful vapors.</li></ul>	



 <b>WARNING</b>	
	Spray contact with electrical wiring can result in electrocution.
<ul style="list-style-type: none"><li>• Keep water spray away from electric wiring or fatal electric shock may result.</li></ul>	



 <b>WARNING</b>	
	Use of pressure washer can create puddles and slippery surfaces.
	High pressure spray could cause you to fall if you are too close to the cleaning surface.
<ul style="list-style-type: none"><li>• Keep spray nozzle between 8 to 24 inches away from cleaning surface.</li><li>• Operate this unit on a stable surface.</li><li>• The cleaning area should have adequate slopes and drainage to reduce the possibility of a fall due to slippery surfaces.</li><li>• Be extremely careful if you must use the pressure washer from a ladder, scaffolding or any other relatively unstable location.</li><li>• Firmly grasp spray gun with both hands when using high pressure spray to avoid injury if gun kicks back.</li></ul>	



 <b>WARNING</b>	
	Fuel and its vapors are extremely flammable and explosive.
	Fire or explosion can cause severe burns or death.
<b>WHEN ADDING FUEL</b> <ul style="list-style-type: none"><li>• Turn pressure washer <b>OFF</b> and let it cool at least 2 minutes before removing gas cap.</li><li>• Fill fuel tank outdoors.</li><li>• <b>DO NOT</b> overfill tank. Allow space for fuel expansion.</li><li>• Keep fuel away from sparks, open flames, pilot lights, heat, and other ignition sources.</li><li>• <b>DO NOT</b> light a cigarette or smoke.</li></ul>	
<b>WHEN OPERATING EQUIPMENT</b> <ul style="list-style-type: none"><li>• <b>DO NOT</b> tip engine or equipment at angle which causes fuel to spill.</li><li>• <b>DO NOT</b> spray flammable liquids.</li></ul>	
<b>WHEN TRANSPORTING OR REPAIRING EQUIPMENT</b> <ul style="list-style-type: none"><li>• Transport/repair with fuel tank <b>EMPTY</b> or with fuel shutoff valve <b>OFF</b>.</li></ul>	
<b>WHEN STORING FUEL OR EQUIPMENT WITH FUEL IN TANK</b> <ul style="list-style-type: none"><li>• Store away from furnaces, stoves, water heaters, clothes dryers or other appliances that have pilot light or other ignition source because they can ignite fuel vapors.</li></ul>	



 <b>WARNING</b>	
	The high pressure stream of water that this equipment produces can pierce skin and its underlying tissues, leading to serious injury and possible amputation.
<ul style="list-style-type: none"><li>• <b>NEVER</b> aim spray gun at people, animals or plants.</li><li>• <b>DO NOT</b> allow <b>CHILDREN</b> to operate pressure washer.</li><li>• <b>NEVER</b> repair high pressure hose. Replace it.</li><li>• Keep high pressure hose connected to pump and spray gun while system is pressurized.</li></ul>	

# Section 1: Safety Rules

 <b>WARNING</b>	
	Running engines produce heat and hot exhaust gases. Temperature of muffler and nearby areas can reach or exceed 150°F (65°C).
	Fire or severe burns can occur.
<ul style="list-style-type: none"><li>• DO NOT touch hot surfaces.</li><li>• Stay clear of exhaust gases.</li><li>• Allow equipment to cool before touching.</li></ul>	

 <b>WARNING</b>	
	Starter and other rotating parts can entangle hands, hair, clothing, or accessories.
<ul style="list-style-type: none"><li>• DO NOT wear loose clothing, jewelry or anything that may be caught in the starter or other rotating parts.</li><li>• Tie up long hair and remove jewelry.</li></ul>	

 <b>WARNING</b>	
	High pressure spray can cause paint chips or other particles to become airborne.
<ul style="list-style-type: none"><li>• Always wear eye protection when using this equipment or in vicinity of where equipment is in use.</li></ul>	

 <b>WARNING</b>	
	Unintentional sparking can result in fire or electric shock.
	
<b>WHEN ADJUSTING OR MAKING REPAIRS TO YOUR PRESSURE WASHER</b>	
<ul style="list-style-type: none"><li>• Disconnect spark plug wire from spark plug and place wire where it cannot contact spark plug.</li></ul>	

 <b>CAUTION</b>	
Excessively high or low operating speeds increase risk of injury and damage to pressure washer.	
<ul style="list-style-type: none"><li>• DO NOT tamper with governed speed.</li><li>• DO NOT operate pressure washer above rated pressure.</li></ul>	

 <b>CAUTION</b>	
A pressure washer produces a high pressure spray which increases risk of injury and damage to unit.	
<ul style="list-style-type: none"><li>• DO NOT secure spray gun in open position.</li><li>• DO NOT leave spray gun unattended while machine is running.</li><li>• NEVER use a spray gun which does not have a trigger lock or trigger guard in place and in working order.</li><li>• Always be certain spray gun, nozzles and accessories are correctly attached.</li></ul>	

<b>CAUTION</b>	
High pressure spray may damage fragile items including glass.	
<ul style="list-style-type: none"><li>• DO NOT point spray gun at glass when in jet spray mode.</li><li>• NEVER aim spray gun at plants.</li></ul>	

<b>CAUTION</b>	
Improper treatment of pressure washer can damage it and shorten its life.	
<ul style="list-style-type: none"><li>• If you have questions about intended use, ask dealer or contact Briggs &amp; Stratton Power Products.</li><li>• NEVER operate units with broken or missing parts, or without protective housing or covers.</li><li>• DO NOT by-pass any safety device on this machine.</li><li>• Before starting pressure washer in cold weather, check all parts of the equipment to be sure ice has not formed there.</li><li>• NEVER move machine by pulling on high pressure hose. Use handle provided on unit.</li><li>• Check fuel system for leaks or signs of deterioration, such as chafed or spongy hose, loose or missing clamps, or damaged tank or cap. Correct all defects before operating pressure washer.</li><li>• This equipment is designed to be used with Briggs &amp; Stratton Power Products authorized parts <b>ONLY</b>. If equipment is used with parts that DO NOT comply with minimum specifications, user assumes all risks and liabilities.</li></ul>	

## KNOW YOUR PRESSURE WASHER

Read this owner's manual and safety rules before operating your pressure washer.

Compare the illustrations with your pressure washer to familiarize yourself with the locations of various controls and adjustments. Save this manual for future reference.

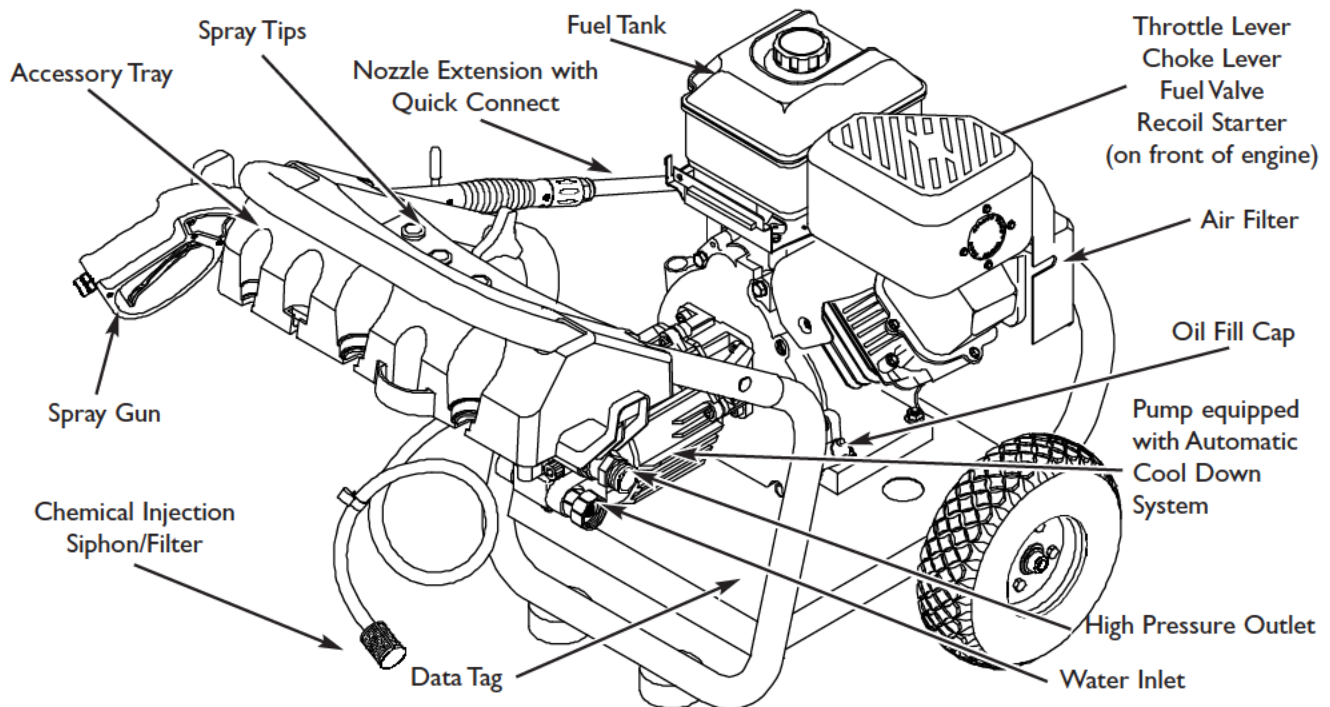

**Accessory Tray** — Provides convenient storage for standard and optional accessories, such as brushes, turbo wands, ect.

**Air Filter** — Protects engine by filtering dust and debris out of intake air.

**Automatic Cool Down System** — Cycles water through pump when water reaches 125°-155°F. Warm water will discharge from pump onto ground. This system prevents internal pump damage.

**Chemical Injection Siphon/Filter** — Use to siphon detergent or other pressure washer chemicals into the low pressure stream.

**Choke Lever** — Prepares a cold engine for starting.

**Data Tag** — Provides model, revision and serial number of pressure washer. Please have these readily available if calling for assistance.

**Fuel Tank** — Fill tank with regular unleaded fuel. Always leave room for fuel expansion.

**Fuel Valve** — Used to turn fuel on and off to engine.

**High Pressure Hose (not shown)** — Connect one end to the water pump and the other end to the spray gun.

**High Pressure Outlet** — To connect high pressure hose.

**Nozzle Extension with Quick Connect** — Allows you to switch between five different spray tips.

**Oil Fill Cap** — Fill engine with oil here.

**Pump** — Develops high pressure.

**Recoil Starter** — Use for starting the engine manually.

**Safety Goggles (not shown)** — Always use the enclosed goggles or other eye protection when running your pressure washer.

**Spray Gun** — Controls the application of water onto cleaning surface with trigger device. Includes safety latch.

**Spray Tips** — Chemical injection, 0°, 15°, 25°, and 40°: for various high pressure cleaning applications.

**Throttle Lever** — Sets engine in starting mode for recoil starter and stops a running engine.

**Water Inlet** — Connect garden hose here.

## ASSEMBLY

**IMPORTANT:** Read entire owner's manual before you attempt to assemble or operate your new pressure washer.

### Remove Pressure Washer From Carton

1. Remove parts bag packed with pressure washer.
2. Slice two corners at end of carton from top to bottom so panel can be folded down flat, then remove all packing material.
3. Roll pressure washer out of carton.

### Carton Contents

#### Items in the carton include:

- Main Unit
- Safety Goggles
- Handle
- Plastic Accessory Tray
- High Pressure Hose
- Spray Gun
- Nozzle Extension with Quick Connect Fitting
- Oil Bottle
- Parts Bag (which includes the following):
  - Owner's Manual
  - Engine Manual
  - Owner's Registration Card
  - Bag containing 5 multi-colored Quick Connect Spray Tips
  - Maintenance Kit
  - Handle Fastening Hardware Kit (which includes):
    - Carriage Bolt
    - "L" Bolt
    - Plastic Knobs (2)
    - "J" Hook
    - Chemical Hose Clip
    - Self Tapping Screws (5)

## PREPARING PRESSURE WASHER FOR USE

If you have any problems with the assembly of your pressure washer or if parts are missing or damaged, call the pressure washer helpline at **1-888-611-6708**.

**To prepare your pressure washer for operation, you will need to perform these tasks:**

1. Fill out and send in registration card.
2. Attach accessory tray to handle, then attach handle to main unit.
3. Add oil to engine crankcase.
4. Add fuel to fuel tank.
5. Connect high pressure hose to spray gun and pump.
6. Connect water supply to pump.
7. Attach nozzle extension to spray gun.
8. Select/attach quick connect spray tip to nozzle extension.

### Attach Handle and Accessory Tray

**NOTE:** All assembly operations given in this section will be described from the perspective of assembling the pressure washer from the rear.

1. Slide plastic accessory tray onto handle and align holes in accessory tray with holes on handle (Figure 1).

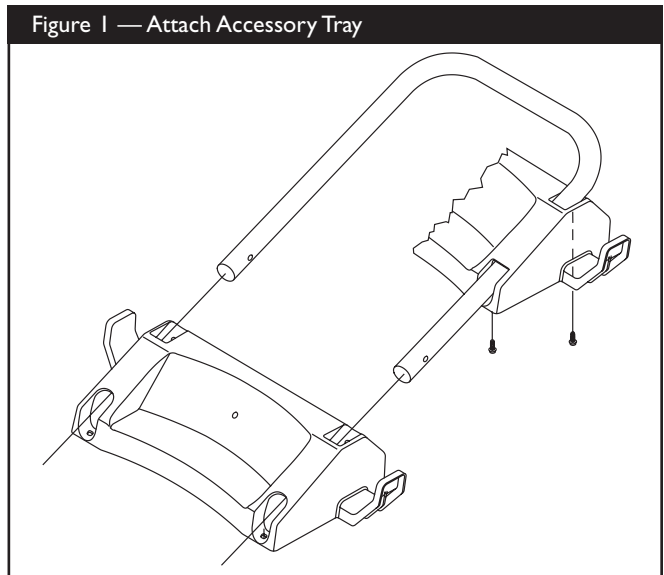

## Section 3: Assembly

- Secure tray to handle with self tapping screws using a #2 phillips screwdriver. Ensure screws are tight but not crushing the plastic accessory tray.
- Place handle assembly onto handle supports connected to main unit. Make sure holes in handle align with holes on handle supports (Figure 2).

Figure 2 — Attach Handle to Base

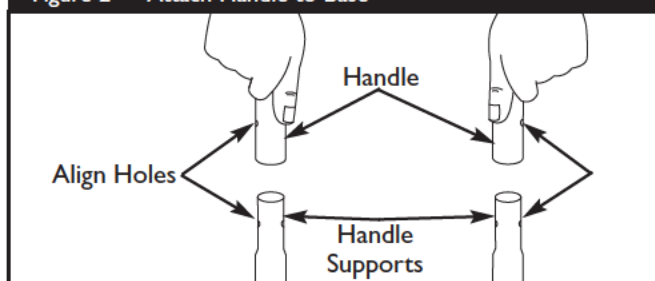

**NOTE:** It may be necessary to move the handle supports from side to side in order to align the handle so it will slide over the handle supports.

- Insert “L” bolt through hole on left side of handle (viewing from handle side of unit) and attach plastic knob. Tighten knob by hand (Figure 3).

Figure 3 — Secure Handle



- Insert carriage bolt through right side hole from outside of unit and attach a plastic knob from inside of unit (viewing unit from the handle side). Tighten by hand (Figure 3).
- Insert “J” hook into second from left slot in accessory tray (Figure 4).

Figure 4 — Install “J” Hook on Accessory Tray

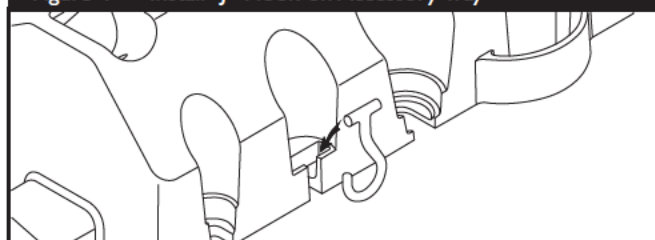

- Pinch chemical hose and slide it into metal clip as shown in Figure 5.

Figure 5 — Slide Chemical Hose into Metal Clip

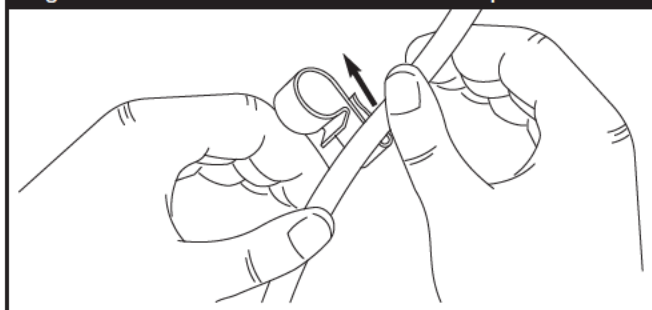

- Tilt unit up by handle and attach metal clip to rib on center underside of accessory tray (Figure 6). Slide chemical hose through metal clip so that it is tight but not kinked.

Figure 6 — Slide Metal Clip onto Accessory Tray Flange

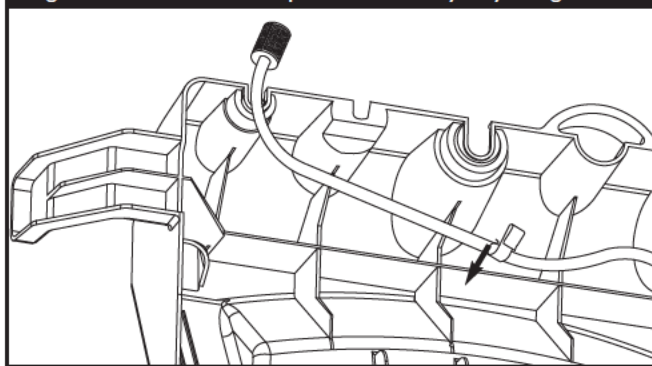

### Add Engine Oil and Fuel

- Place pressure washer on a level surface.
- Refer to engine owner's manual and follow oil and fuel recommendations and instructions.

#### CAUTION

Any attempt to crank or start the engine before it has been properly filled with the recommended oil will result in equipment failure.

- Refer to engine manual for oil and fuel fill information.
- Damage to equipment resulting from failure to follow this instruction will void warranty.

**NOTE:** Check oil often during engine break-in. Refer to engine owner's manual for recommendations.

# Section 3: Assembly

## Connect Hose and Water Supply to Pump

**IMPORTANT:** To avoid pump damage, you must assemble the nozzle extension to the spray gun and attach all hoses before you start the engine.

**NOTE:** Your pressure washer comes with a quick connect that you can use to attach the high pressure hose to either the spray gun or pump.

1. Uncoil high pressure hose and attach female quick connect to one end of hose. Attach male quick connect to gun (Figure 7).

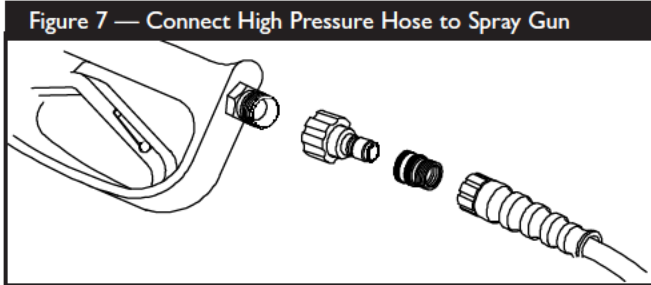

2. Attach end of hose to base of spray gun (Figure 7). Pull down on collar of quick connect, slide fitting into pump and let go of collar. Pull on hose to be sure of a tight connection.

**NOTE:** The quick connect is shown connecting the high pressure hose to the spray gun. If you choose to use the quick connect for the hose to pump connection, follow the same directions to attach quick connect from hose to pump.

3. Attach other end of high pressure hose to high pressure outlet on pump (Figure 8). Tighten by hand.

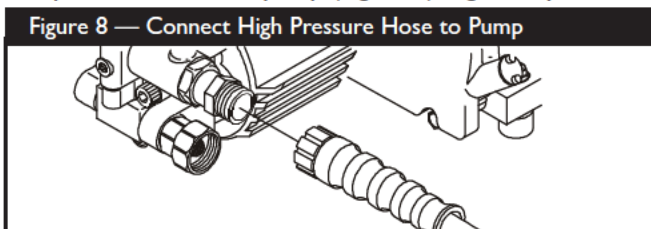

4. Before connecting garden hose to water inlet, inspect inlet screen (Figure 9). Clean screen if it contains debris, replace it if it is damaged. **DO NOT RUN PRESSURE WASHER IF SCREEN IS DAMAGED.**

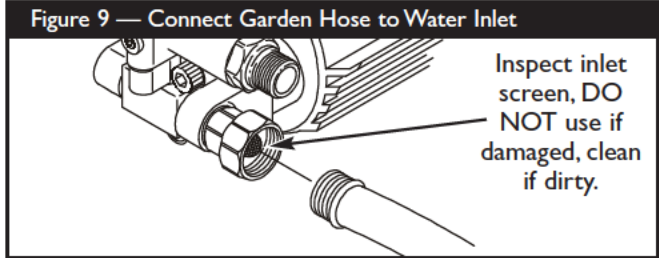

5. Run water through garden hose for 30 seconds to clean out any debris. Turn off water.

**IMPORTANT:** DO NOT siphon standing water for the water supply. Use ONLY cold water (less than 100°F).

6. Connect garden hose (not to exceed 50 feet in length) to water inlet. Tighten by hand (Figure 9).

**CAUTION**

There **MUST** be at least ten feet of unrestricted garden hose between the pressure washer inlet and any flow shut off device, such as a 'Y' shut-off connector or other convenience-type water shut-off valve.

- Damage to equipment resulting from failure to follow this instruction will void warranty.

7. Turn **ON** the water and squeeze the trigger on the spray gun to purge the pump system of air and impurities.

**WARNING**



High pressure spray can cause paint chips or other particles to become airborne.

- Always wear eye protection when using this equipment or in vicinity of where equipment is in use.
- Before starting the pressure washer, be sure you are wearing adequate eye protection.

## Checklist Before Starting Engine

Review the unit's assembly to confirm you have performed all of the following:

1. Make sure handle is in place and secure.
2. Check that oil has been added to the proper level in engine crankcase.
3. Add proper fuel to fuel tank.
4. Check for properly attached hose connections.
5. Check to make sure that there are no kinks, cuts, or damage to high pressure hose.
6. Provide a proper water supply at an adequate flow.
7. Be sure to read "Safety Rules" and "How To Use Your Pressure Washer" before using pressure washer.



## HOW TO USE YOUR PRESSURE WASHER

If you have any problems operating your pressure washer, please call the pressure washer helpline at **1-888-611-6708**.

### To Start Pressure Washer

To start your pressure washer for the first time, follow these instructions step-by-step. This starting information also applies if you have let the pressure washer sit idle for at least a day.

1. Place pressure washer near an outside water source capable of supplying water at a flow rate greater than 3.6 gallons per minute and no less than 20 PSI at pressure washer end of garden hose.
2. Check that high pressure hose is connected to spray gun and to pump. See "Preparing Pressure Washer for Use" for illustrations.
3. Make sure unit is in a level position.
4. Connect garden hose to water inlet on pressure washer pump. **Turn ON water.**

### CAUTION

**DO NOT** run the pump without the water supply connected and turned on.

- Damage to equipment resulting from failure to follow this instruction will void warranty.

5. Squeeze trigger on gun until you have a steady stream of water. This purges pump of air and impurities.

6. Attach nozzle extension to spray gun (Figure 10). Tighten by hand.

Figure 10 — Connect Nozzle Extension to Spray Gun

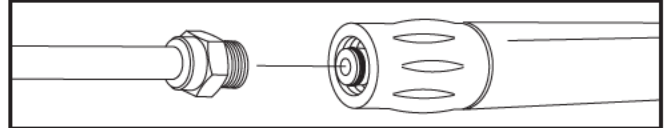

7. Choose spray tip you want to use and insert it into nozzle extension. See "How to Use Spray Tips" on page 10.

8. Engage safety latch to spray gun trigger (Figure 11).

Figure 11 — Spray Gun with Safety Latch Engaged

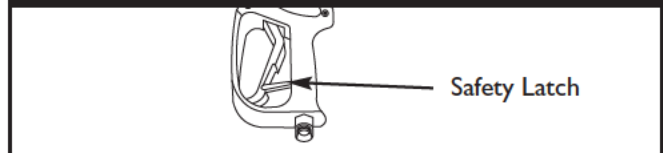

9. Move variable pressure control lever to "High" position, shown on engine as a rabbit (Figure 12).

Figure 12 - Variable Pressure Control Lever

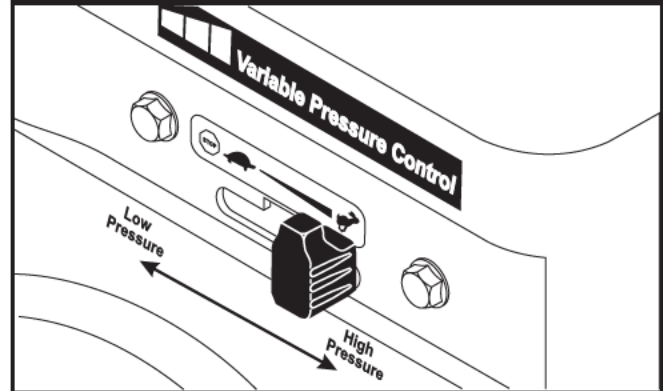

## Section 4: Operation

---

10. Start engine according to instructions given in the engine owner's manual.

**NOTE:** If the recoil starter is hard to pull, it may be necessary to squeeze the gun trigger to relieve internal pump pressure.



### CAUTION

Avoid injury from kickback.

- Squeeze trigger on spray gun each time recoil starter is pulled and engine fails to start.

### How to Stop Your Pressure Washer

- Move variable pressure control lever to “**Stop**” position.
- Turn engine off according to instructions given in the engine owner's manual.
- **Squeeze trigger on the spray gun to relieve pressure in the hose.**

**NOTE:** A small amount of water will squirt out when you release the pressure.

### How to Use Accessory Tray

The unit is equipped with an accessory tray with places to store your nozzle extension and quick connect spray tips, and slots to hold the cleaning solution bottle and the detergent siphoning filter. There are also two hooks at the ends of the handle to hold your spray gun and high pressure hose.

**NOTE:** The extra holes in the tray are for storing a brush and a turbo wand. The brush and turbo wand are **NOT** included with your pressure washer. You can buy these items as optional accessories.

1. Place nozzle extension through hole on accessory tray, as shown in Figure 13.

Figure 13 — Typical Accessory Tray

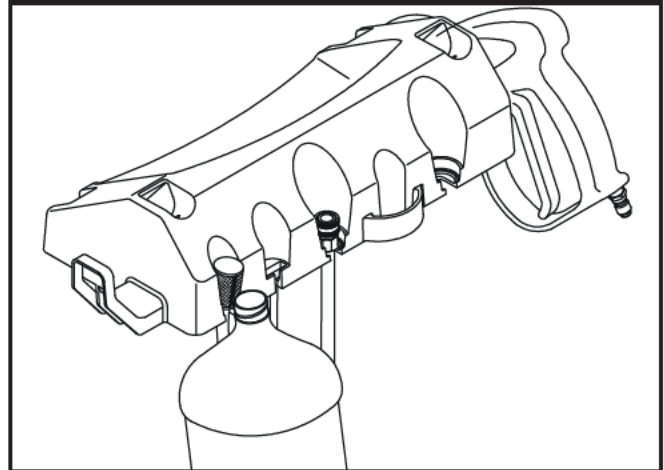

2. Hang chemical solution bottle on “J” hook and place detergent siphoning filter in last slot on left (Figure 13).
3. Place spray gun on hook attached to accessory tray on right side of unit (Figure 13).
4. Hang high pressure hose on hook attached to accessory tray on left side of unit as shown on page 4.

# Section 4: Operation

## How to Use Spray Tips

The quick-connect on the nozzle extension allows you to switch between five different spray tips. The spray tips vary the spray pattern as shown below (Figure 8).

### CAUTION

A pressure washer produces a high pressure spray which increases risk of injury and damage to unit.

- NEVER exchange spray tips without locking the safety latch on the trigger.

### Follow these instructions to change spray tips:

1. Engage safety latch on spray gun.
2. Pull back collar on quick-connect and pull current spray tip off. Store spray tips in space provided on handles storage panel.
3. Select desired spray tip:
  - For gentle rinse, select white 40° or green 25° spray tip.
  - To scour surface, select yellow 15° or red 0° spray tip.
  - To apply chemical, select black spray tip.
3. Pull back on collar, insert new spray tip and release collar. Tug on spray tip to make sure it is securely in place.
4. For most effective cleaning, keep spray tip from 8 to 24 inches away from cleaning surface. If you get spray tip too close, you may damage cleaning surface. DO NOT get closer than 6 inches when cleaning tires.

## Cleaning and Applying Chemical

**IMPORTANT:** Use soaps designed specifically for pressure washers. Household detergents could damage the pump.

### CAUTION

You must attach all hoses before you start the engine.

- Starting the engine without all the hoses connected and without the water turned ON will damage the pump.
- Damage to equipment resulting from failure to follow this instruction will void warranty.

### To apply detergent follow these steps:

1. Review spray tip use.
2. Prepare detergent solution as required by manufacturer.
3. Hang detergent solution on “J” hook attached to accessory tray, as shown in Figure 15.

Figure 15 — Insert Filter into Container

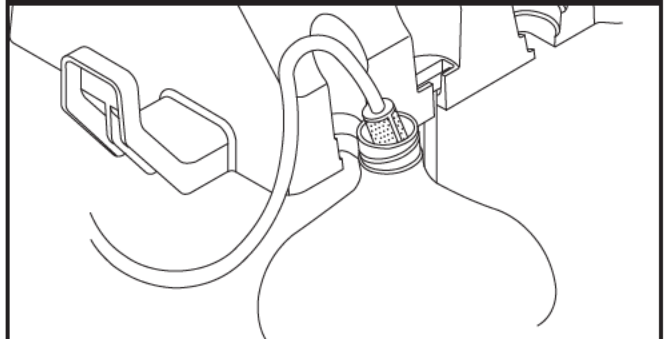
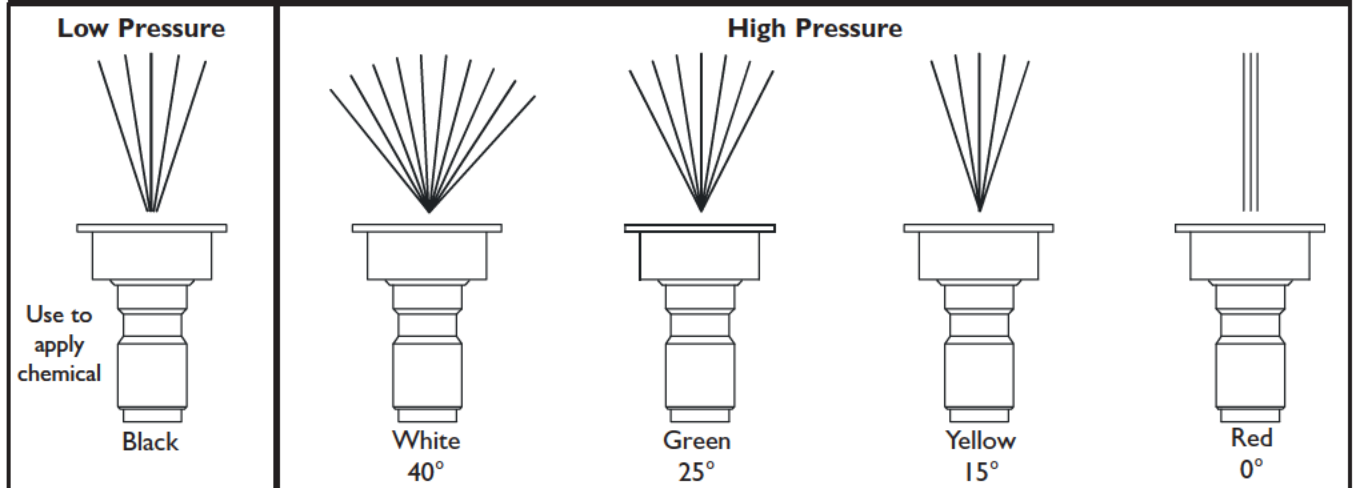

Figure 14 — Spray Tips



# Section 4: Operation

- Place small filter end of detergent siphoning tube into detergent container.

<b>CAUTION</b>
Keep the chemical injection tube from coming in contact with the hot muffler.
<ul style="list-style-type: none"> <li>When inserting the filter into a detergent solution bottle, route the tube so as to keep it from inadvertently contacting the hot muffler.</li> </ul>

- Make sure black spray tip is installed.

**NOTE:** Detergent cannot be applied with the high pressure spray tips (White, Green, Yellow, or Red).

- Make sure garden hose is connected to water inlet. Check that high pressure hose is connected to spray gun and pump and start engine.
- Apply detergent to a dry surface, starting at lower portion of area to be washed and work upward, using long, even, overlapping strokes.
- Allow detergent to soak in between 3–5 minutes before washing and rinsing. Reapply as needed to prevent surface from drying. **DO NOT** allow detergent to dry on (prevents streaking).

**IMPORTANT:** You must flush the chemical injection system after each use by placing the filter into a bucket of clean water, then run the pressure washer in low pressure for 1-2 minutes.

## Pressure Washer Rinsing

### Wash and Rinse Surface

This pressure washer permits regulation of output water pressure by varying the engine speed. The variable pressure control lever found on the front of the engine may be set, as shown in Figure 16:

Pressure	Low	to	High
Duty	Light	Medium	Heavy
Application	Auto Boat Furniture	Concrete Driveway Deck	Paint removal Degreasing

**After you have applied detergent, scour the surface and rinse it clean as follows:**

- Apply safety latch to spray gun.
- Remove black chemical nozzle from nozzle extension.
- Select and install desired high pressure nozzle following instructions “How to Use Spray Tips” on page 10.

	<b>WARNING</b>
High pressure spray could cause you to fall if you are too close to the cleaning surface.	
<ul style="list-style-type: none"> <li>Keep spray nozzle between 8 to 24 inches away from cleaning surface.</li> <li>Operate this unit on a stable surface.</li> <li>Be extremely careful if you must use the pressure washer from a ladder, scaffolding or any other relatively unstable location.</li> <li>Firmly grasp spray gun with both hands when using high pressure spray to avoid injury if gun kicks back.</li> </ul>	

- Keep spray gun a safe distance from the area you plan to spray.
- Adjust spray pressure by sliding variable pressure control lever left or right, as shown in Figure 12 on page 8.
- Apply a high pressure spray to a small area and then check the surface for damage. If no damage is found, you can assume it is okay to continue rinsing.
- Start at top of area to be rinsed, working down with same overlapping strokes as you used for cleaning.

## Automatic Cool Down System (Thermal Relief)

If you run the engine on your pressure washer for 3-5 minutes without pressing the trigger on the spray gun, circulating water in the pump can reach temperatures above 125°F. The system engages to cool the pump by discharging the warm water onto the ground.

## GENERAL MAINTENANCE RECOMMENDATIONS

The pressure washer warranty does not cover items that have been subjected to operator abuse or negligence. To receive full value from the warranty, the operator must maintain the pressure washer as instructed in this manual.

- Some adjustments will need to be made periodically to properly maintain your pressure washer. Check the spray gun and adjustable nozzle extension assembly for wear.
- All maintenance in this manual and the engine owner's manual should be made at least once each season.
- Once a year you should clean or replace the spark plug, clean or replace the air filter. A new spark plug and clean air filter assure proper fuel-air mixture and help your engine run better and last longer. Please refer to your engine owner's manual for more details.
- If equipped with inflatable tires, keep the air pressure at the value marked on the tire or within 15 and 40 psi.

### Before Each Use

1. Check engine oil level.
2. Check water inlet screen for damage.
3. Check in-line filter for damage.
4. Check high pressure hose for leaks.
5. Check detergent siphoning tube and filter for damage.
6. Check spray gun and nozzle extension assembly for leaks.
7. Rinse out garden hose to flush out debris **before** connecting to pressure washer.

## PRESSURE WASHER MAINTENANCE

### Check and Clean Inlet Screen

Examine the screen on the water inlet. Clean it if the screen is clogged or replace it if screen is damaged.

### Check High Pressure Hose

The high pressure hose can develop leaks from wear, kinking, or abuse. Inspect the hose each time before using it. Check for cuts, leaks, abrasions or bulging of cover, damage or movement of couplings. If any of these conditions exist, replace the hose immediately.

### WARNING



The high pressure stream of water that this equipment produces can pierce skin and its underlying tissues, leading to serious injury and possible amputation.

- NEVER repair high pressure hose. Replace it.
- Replacement hose rating MUST exceed maximum pressure rating of unit.

### Check Detergent Siphoning Tube

Examine the filter on the detergent tube and clean if clogged. The tube should fit tightly on the barbed fitting. Examine the tube for leaks or tears. Replace the filter or tube if either is damaged.

### Cleaning Detergent Siphoning Tube

If you used the detergent siphoning tube, you must flush it with clean water before stopping the engine.

1. Place chemical injection siphon/filter in a bucket full of clean water.
2. Attach black low pressure spray tip.
3. Flush for 1-2 minutes.
4. Shut off engine.

**IMPORTANT:** Simply shutting **OFF** engine will not release pressure in the system. **When the engine has shut down, squeeze the trigger on the spray gun to relieve the pressure in the hose.**

### Check Gun and Nozzle Extension

Examine the hose connection to the spray gun and make sure it is secure. Test the trigger by pressing it and making sure it "springs back" into place when you release it. Put the safety latch in the ON position and test the trigger. You should not be able to press the trigger.

### Check In-Line Filter

Refer to Figure 17 and service the in-line filter if it becomes clogged, as follows:

Figure 17 — Clean In-Line Filter

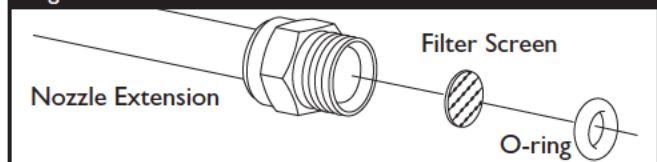

1. Detach spray gun and nozzle extension from high pressure hose. Detach nozzle extension from spray gun and remove o-ring and screen from nozzle extension.

## Section 5: Maintenance

Flush screen, spray gun, and nozzle extension with clean water to clear debris.

2. If screen is damaged, the o-ring kit contains a replacement in-line filter screen and o-ring. If undamaged, reuse screen.
3. Place in-line filter screen into threaded end of nozzle extension. Direction does not matter. Push screen in with eraser end of pencil until it rests flat at bottom of opening. Take care to not bend the screen.
4. Place o-ring into recess. Push o-ring snugly against in-line filter screen.
5. Assemble nozzle extension to spray gun, as described earlier in manual.

### Purge Pump of Air and Contaminants

To remove air from the pump, follow these steps:

1. Set up pressure washer as described in "Preparing Pressure Washer For Use". Connect water supply and turn water on.
2. Pull trigger on spray gun and hold.
3. When water supply is steady and constant, engage safety latch.

To remove contaminants from the pump, follow these steps:

1. Set up pressure washer as described in "Preparing Pressure Washer For Use". Connect water supply and turn water on.
2. Start engine according to instructions in "To Start Pressure Washer".
3. Remove nozzle extension from spray gun.
4. Squeeze trigger on the spray gun and hold.
5. When water supply is steady and constant, engage safety latch and reattach nozzle extension.

### Nozzle Maintenance

A pulsing sensation felt while squeezing the spray gun trigger may be caused by excessive pump pressure. The principal cause of excessive pump pressure is a spray tip clogged or restricted with foreign materials, such as dirt, etc. To correct the problem, immediately clean the spray tip using the tools included with your pressure washer and follow these instructions:

1. Shut off engine and turn off water supply.
2. Remove spray tip from end of nozzle extension.
3. Remove in-line filter from other end of nozzle extension.
4. Use wire included in kit (or a small paper clip) to free any foreign material clogging or restricting spray tip (Figure 18).

Figure 18 — Nozzle Maintenance

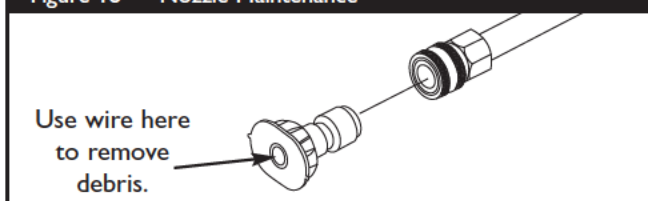

5. Using a garden hose, remove additional debris by back flushing water through nozzle extension (Figure 19). Back flush between 30 to 60 seconds.

Figure 19 — Backflushing the Nozzle Extension

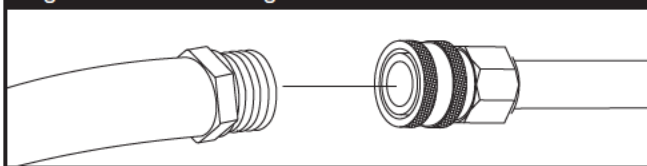

6. Reinstall spray tip and in-line filter into nozzle extension.
7. Reconnect nozzle extension to spray gun.
8. Reconnect water supply, turn on water, and start engine.
9. Test pressure washer by operating with each Quick Connect spray tip.

### O-Ring Maintenance

Through the normal operation of your pressure washer, o-rings, which keep the connections of the hoses and spray gun tight and leak-free, may become worn or damaged.

An O-Ring Maintenance Kit is provided with your pressure washer which includes replacement o-rings, rubber washer and water inlet filter. Refer to the instruction sheet provided in the kit to service your unit's o-rings. Note that not all of the parts in the kit will be used on your unit.

To remove a worn or damaged o-ring, use a small flathead screwdriver to get underneath the o-ring and pry it off.

## ENGINE MAINTENANCE

See the engine owner's manual for instructions on how to properly maintain the engine.

### CAUTION

Avoid prolonged or repeated skin contact with used motor oil.

- Used motor oil has been shown to cause skin cancer in certain laboratory animals.
- Thoroughly wash exposed areas with soap and water.



KEEP OUT OF REACH OF CHILDREN. DON'T POLLUTE. CONSERVE RESOURCES. RETURN USED OIL TO COLLECTION CENTERS.

### Data Tag

Data tag information is very important if you need help from our Customer Service Department or an authorized service dealer.

- The data tag (Figure 20) is located on the base of the pressure washer. For future reference, please copy the model, revision, and serial number of the pressure washer in the space below.

Figure 20 — Data Tag

MODEL	<input type="text"/>	Copy Model Number Here
REV NO	<input type="text"/>	Copy Revision Here
SERIAL	<input type="text"/>	Copy Serial Number Here
PSI	<input type="text"/>	
GPM	<input type="text"/>	



## PREPARING THE UNIT FOR STORAGE

Water should not remain in the unit for long periods of time. Sediments or minerals can deposit on pump parts and “freeze” pump action. If you do not plan to use the pressure washer for more than 30 days, follow this procedure:

1. Flush detergent siphoning tube by placing the filter into a pail of clean water while running pressure washer in low pressure mode. Flush for one to two minutes.
2. Shut off the engine and let it cool, then remove high pressure and garden hoses. Disconnect spark plug wire from spark plug.
3. Empty the pump of liquids by pulling the engine recoil handle about 6 times. This should remove most of the liquid in the pump.
4. Use pump saver to prevent corrosion build up and freezing of pump.
5. Store unit in a clean, dry area.

### Protecting the Pump

To protect the pump from damage caused by mineral deposits or freezing, use PumpSaver to treat pump. This prevents freeze damage and lubricates pistons and seals.

**NOTE:** PumpSaver is available as an optional accessory. It is not included with the pressure washer. Contact the nearest authorized service center to purchase PumpSaver.

### CAUTION

You must protect your unit from freezing temperatures.

- Failure to do so will permanently damage your pump and render your unit inoperable.
- Freeze damage is not covered under warranty.



### CAUTION

Read and follow all cautions and warnings on the PumpSaver can label.

- Always wear eye protection when using PumpSaver.

To use PumpSaver, make sure the pressure washer is turned off and disconnected from supply water. Read and follow all instructions and warnings given on the PumpSaver container.

**NOTE:** PumpSaver will drip from pump after treatment and will stain wood and concrete.

**NOTE:** If PumpSaver is not available, draw RV antifreeze (non-alcohol) into the pump by pouring the solution into a 3-foot section of garden hose connected to inlet adapter and pulling recoil handle twice.

## STORING THE ENGINE

See the engine owner’s manual for instructions on how to properly prepare the engine for storage.



## TROUBLESHOOTING

Problem	Cause	Correction
<b>Pump has following problems: failure to produce pressure, erratic pressure, chattering, loss of pressure, low water volume.</b>	<ol style="list-style-type: none"> <li>1. Low pressure spray tip installed.</li> <li>2. Water inlet is blocked.</li> <li>3. Inadequate water supply.</li> <li>4. Inlet hose is kinked or leaking.</li> <li>5. Clogged inlet hose strainer.</li> <li>6. Water supply is over 100°F.</li> <li>7. High pressure hose is blocked or leaks.</li> <li>8. Gun leaks.</li> <li>9. Nozzle is obstructed.</li> <li>10. Pump is faulty.</li> </ol>	<ol style="list-style-type: none"> <li>1. Replace spray tip with high pressure spray tip.</li> <li>2. Clear inlet.</li> <li>3. Provide adequate water flow.</li> <li>4. Straighten inlet hose, patch leak.</li> <li>5. Check and clean inlet hose strainer.</li> <li>6. Provide cooler water supply.</li> <li>7. Clear blocks in outlet hose.</li> <li>8. Replace gun.</li> <li>9. Clean nozzle.</li> <li>10. Contact Authorized service facility.</li> </ol>
<b>Detergent fails to mix with spray.</b>	<ol style="list-style-type: none"> <li>1. Detergent siphoning tube is not submerged.</li> <li>2. Chemical filter is clogged or cracked.</li> <li>3. Dirty in-line filter.</li> <li>4. High pressure spray tip installed.</li> </ol>	<ol style="list-style-type: none"> <li>1. Insert detergent siphoning tube into detergent.</li> <li>2. Clean or replace filter/detergent siphoning tube.</li> <li>3. See "Check In-Line Filter".</li> <li>4. Replace spray tip with low pressure spray tip.</li> </ol>
<b>Engine shuts down during operation.</b>	Out of gasoline.	Fill fuel tank.

# Exploded Views and Parts Lists

## EXPLODED VIEW AND PARTS LIST — UNIT

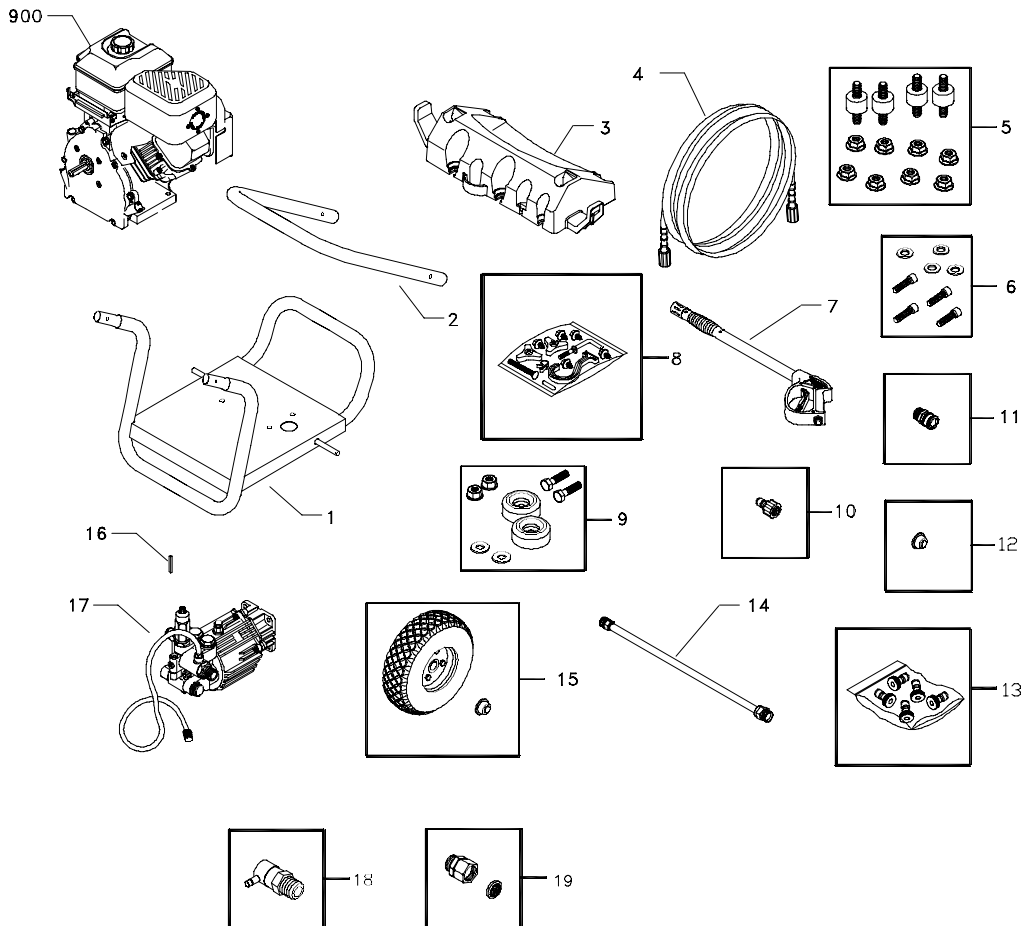

Item	Part #	Description	Item	Part #	Description
1	B190156GS	BASE	11	95518GS	QUICK CONNECT,Wand/Acc
2	B187602GS	HANDLE	12	190147GS	PUSHNUT
3	I92096GS	ASSY, Billboard	13	190717GS	KIT, Spray Tip
4	I85877GS	HOSE	14	190779GS	EXTENSION
5	I92134GS	KIT, Engine Mounting Hardware	15	I92526GS	KIT, Wheel
6	I92131GS	KIT, Pump Mounting Hardware	16	23139BGS	KEY
7	I90049GS	GUN	17	I93087GS	ASSY, Pump (see page 19)
8	I90668GS	KIT, Handle Fasteners	18	B1554GS	RELIEF,Thermal
9	I92553GS	KIT,Vibration Mount	19	I92135GS	KIT, Garden Hose Inlet
10	95519GS	QUICK CONNECT,Wand End	900	NSP	ENGINE

### Items Not Illustrated:

Part #	Description
I93121GS	MANUAL, Owner's
I92554GS	KIT, Decals
BB3061BGS	OIL, Engine
I91922GS	KIT, O-RING MAINT & NZZL CLNNG

# Section 8: Exploded Views and Parts Lists

## EXPLODED VIEW AND PARTS LIST — PUMP

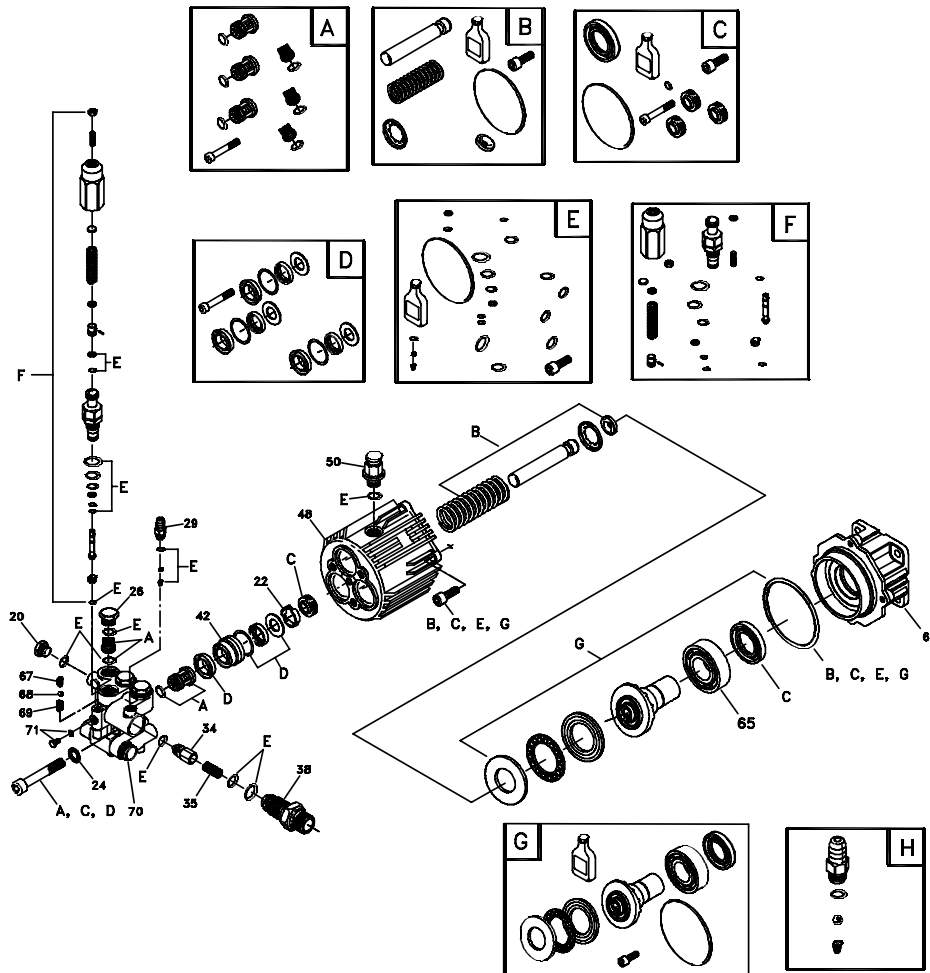

Item	Part #	Description
20	190638GS	PLUG
22	190639GS	SPACER
24	190640GS	WASHER
26	190641GS	PLUG
29	190642GS	HOSE TAIL
34	190643GS	JET
35	190644GS	SPRING
38	190645GS	INJECTOR, Detergent
42	190646GS	PISTON, Guide
48	190647GS	HOUSING
50	191441GS	VENT, CAP
64	193124GS	FLANGE
65	193125GS	BALL BEARING
67	190651GS	GRUB SCREW
68	190652GS	BALL

Item	Part #	Description
69	190653GS	SPRING
70	190654GS	PUMP HEAD
71	190655GS	GRUB SCREW & WASHER
72	190656GS	OIL BOTTLE
A	190657GS	KIT, CHECK VALVE
B	190658GS	KIT, PISTON SET
C	193129GS	KIT, SEAL OIL
D	190660GS	KIT, SEAL HIGH PRESSURE
E	190677GS	KIT, O-RINGS
F	193126GS	KIT, UNLOADER
G	193127GS	KIT, CAM & BEARING
H	192914GS	KIT, CHEMICAL INJECT

**NOTE:** Item letters A - H are service kits and include all parts shown within the box.